

Article number: 20652038

Description: E+G Centring bore clamp GN 411.2-46.5-K

Measures

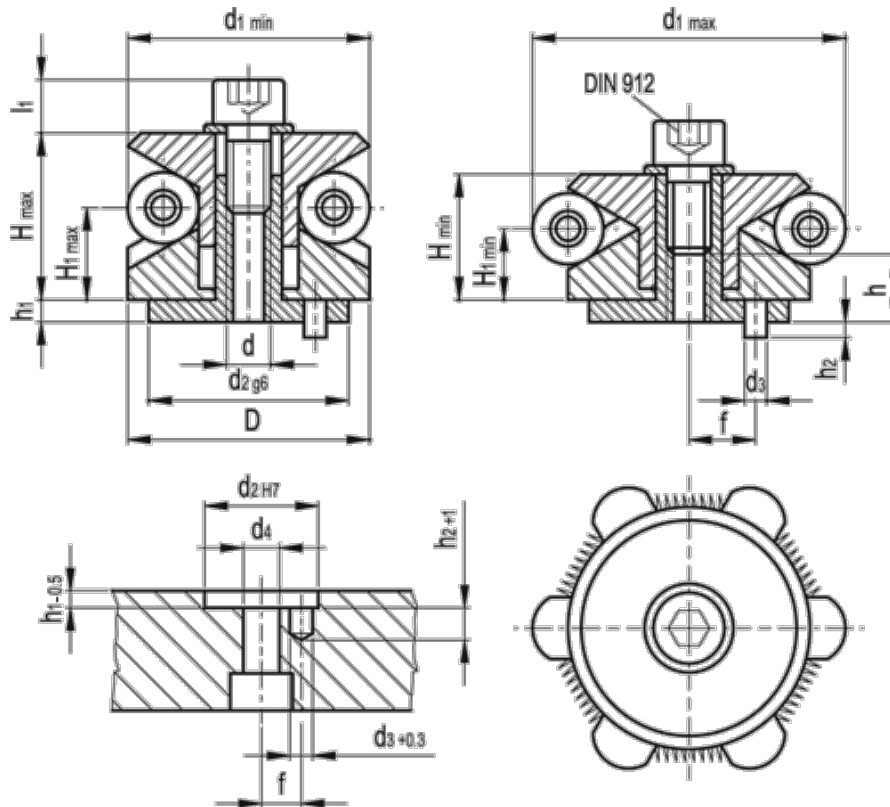

Clamping force (kN) = 6.50	d4 = 8.4	H min = 19.5
Clamping points = 6	f +/-0.1 = 11.0	l1 = 11.5
D = 46.5	h1 = 3.5	Weight (g) = 323
d = M8	H1 max = 15.1	
d1 max = 54.5	H1 min = 12.7	
d1 min = 46.5	h2 = 5.0	
d2 g6/H7 = 30	H max = 24.1	
d3 = 4.0	h min = 8	